



# **JASIC**<sup>®</sup>

## Guide To MIG/MAG Welding





**This guide is designed to provide helpful information relating to the electric arc welding and cutting process.**

**The guide is split into specific areas of welding and cutting and designed to give an understanding of these areas.**

The guide is not designed to be a comprehensive text book and the concept is to convey knowledge and techniques by theory and practical methods.

It should be understood that methods may not be the “only way to do it” but represent many current practices and systems.

The guides are constantly reviewed to incorporate any changes in procedures, technologies and equipment.

Wilkinson Star Limited own full copyright in respect of this manual and its reproduction.

No part of this manual may be reproduced by any means photocopy, electronic, mechanical or otherwise without the prior written permission of Wilkinson Star Limited.



# Contents

|                                       |    |
|---------------------------------------|----|
| What Is Welding?                      | 4  |
| General Safety Instructions           | 8  |
| What Is The MIG/MAG Process?          | 13 |
| What Makes Up The MIG Machines        | 14 |
| The Wire Feeding Systems              | 15 |
| The Welding Gun                       | 18 |
| The Consumables                       | 20 |
| Controls                              | 22 |
| Modes Of Transfer                     | 25 |
| Key Advantages To MIG                 | 28 |
| MIG/MAG Process Applications          | 30 |
| MIG/MAG Process Features And Benefits | 32 |
| Maintaining The System                | 34 |
| MIG Welding Problems                  | 35 |
| Duty Cycle Explained                  | 36 |



Tailored courses using the latest equipment and technology, modules include:

Health & Safety • Electrical Principles in Arc Welding  
MIG • TIG • MMA • Plasma Cutting • Resistance Welding

**Read these instructions carefully before commencing welding**



# What Is Welding?

Welding is the process of joining together two or more pieces using heat and/or pressure to form a high strength joint. There are many ways to perform a weld and these require different skill levels and can utilise many levels of technology in the equipment used.

To carry out a weld a heat source is required. This can be thermo chemical energy which is produced using a combination of gases such as oxygen and acetylene to produce a flame. This process was widely used but requires a high level of manual skill and dexterity.

Another source is electrical energy, this is where an arc is established between the electrical source or Arc welding power source and the work piece. This process is referred to as Arc welding or Arc cutting and can produce heat at temperatures from 3000°C to 20,000°C. Arc welding can be used on a wide range of different metals, alloys and materials. Dependent on the process and welding result required Arc welding requires different skill and dexterity levels. Arc welding uses a wide range of power source types from basic transformers to equipment which utilises high levels of technology.

The applications which utilise Arc welding are extensive, from DIY to nuclear, structural fabrication to aerospace, vehicle repair to vehicle assembly, robot automation to offshore, the list is endless. Welding can be carried out pretty much anywhere...

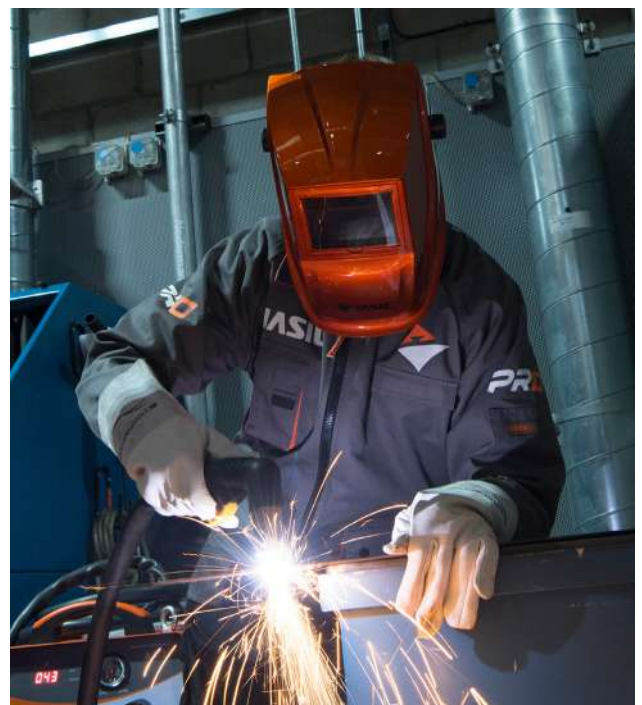

The Arc welding and cutting processes covered:

- Manual metal arc
- MIG (Metal inert gas) process
- MAG (Metal active gas) process
- FCW (Flux cored welding) process
- TIG (Tungsten inert gas) process
- Plasma arc cutting process
- Resistance welding

The individual process information will be given in the related units. In addition to the above processes there are others such as laser, submerged arc, ultrasound and friction welding.



## The Materials Welded?

The most commonly welded materials are aluminium, mild steel, stainless steel and their alloys. Also in today's rapidly changing world many plastics can also be welded.

## Which Process?

The welding process used is chosen based on the materials to be welded and the material thickness. Also to be taken into consideration is the production rate and visual aesthetics of the weld which may be on show.

## Manual Arc (MMA)

This is one of the oldest processes and is still in common use. It is well suited to use when welding outdoors and in repair work. It is a slow process however and requires a high skill level but can be used on a wide range of materials. It can also be used in confined areas as the electrodes can be bent into shape for access. Equipment costs are lower than the other processes.

## Metal Inert/Active Gas (MIG/MAG)

The process is a common, versatile welding process. It provides high deposition rates and is suited to a wide range of material thicknesses, thin to thick. Compared with Manual Arc welding the process provides a weld with minimal weld finishing as there is minimal spatter and no electrode slag. It requires a low - medium skill level and has less problems to achieve good quality compared to TIG/ MMA it has a narrow heat affected area. Its disadvantage is the torch as it is subject to a number of wear components such as contact tips, nozzles, liners etc. It is often a process that is automated to provide even higher production rates.

## Flux Cored Welding (FCW)

Flux cored welding is a type of MIG/MAG welding using a standard MIG/MAG power source but uses a consumable which may contain a core of constituents which allow the process to self-shield itself therefore requiring no additional gas shield supply. This makes it suitable for welding in areas where there may be draughts e.g. outdoors. In addition, consumables may contain elements to provide high deposition rates and hence productivity. The flux core however produces a slag coating which needs to be cleaned after welding.

## Tungsten Inert Gas (TIG)

TIG welding, is an arc welding process that uses a non-consumable tungsten electrode to produce the weld. The weld area and electrode is protected from oxidation or other atmospheric contamination by an inert shielding gas (argon or helium) and a filler metal is normally used, though some welds known as autogenous welds, do not require it. A constant-current welding power supply produces the electrical energy which is conducted across the arc through a column of highly ionized gas. TIG offers a high quality weld although generally a slower process compared to the others which requires a higher skill level.

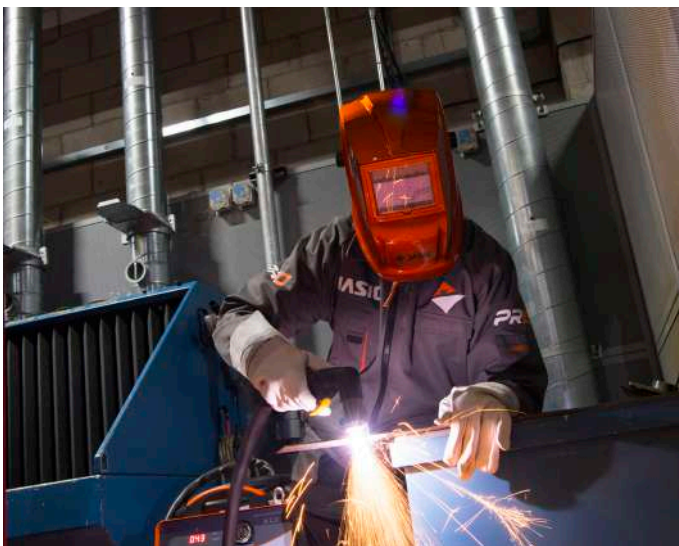

## Resistance Welding (Spot)

Resistance welding (Spot) is also one of the oldest of the electric welding processes in use in the welding industry today. The weld is made by a combination of heat, pressure and time. It is the resistance of the material to be welded to current flow that creates a localised heating in the material to be welded and hence the name resistance welding. The resistance of different materials will create different levels of heat for the same current passing through it. The pressure exerted by the electrode arms and electrode tips through which the current flows, holds the parts to be welded in intimate contact before, during and after the welding current time cycle. The required amount of time current flows in the joint is determined by material thickness and type, the amount of current flowing and the cross-sectional area of the welding tip contact surfaces.



## Plasma Cutting

The basic principle is that the arc formed between the electrode and the work piece is constricted by a fine bore nozzle. This constriction increases the temperature and velocity of the plasma emanating from the nozzle. The temperature of the plasma arc is in excess of 20,000°C and the velocity can approach the speed of sound. When used for cutting, the plasma gas flow is high and creates a deeply penetrating high temperature plasma jet thereby cutting through the material. The force of the arc blows away any molten material in the form of dross. The plasma process operates by using the high temperature arc to melt the metal. The plasma process can therefore be used to cut metals including cutting metals which form refractory oxides such as stainless steel, aluminium, cast iron and non-ferrous alloys. The cut quality is dependent on many parameters but the system is easy to use and often is the only practical or cost effective solution.

## Industry Examples That Use Welding And Cutting Processes:



## Process Comparison:

|                       | TIG Welding                           | MMA Welding                                                 | MIG Welding                                                 |
|-----------------------|---------------------------------------|-------------------------------------------------------------|-------------------------------------------------------------|
| Skill level required  | High                                  | High - Especially for high quality and non ferrous material | Low - Medium                                                |
| Quality               | Requires high skills for good quality | Requires high skills for good quality                       | Less problems to achieve good quality compared to TIG/MMA   |
| Distortion/heat input | High                                  | High                                                        | Low - Narrow heat affected area                             |
| Ease of mechanisation | Some difficult positions              | Difficult                                                   | Simple                                                      |
| Equipment maintenance | Needs training                        | Needs basic training                                        | Needs training                                              |
| Consumable parts      | Negligible                            | Negligible                                                  | Torch components such as contact tips, nozzles, liners etc. |

Equipment must only be used for the purpose it was designed for. Using it in any other way could result in damage or injury and in breach of the safety rules. Only suitably trained and competent persons should use the equipment. Operators should respect the safety of other persons. **PPE and workplace safety equipment must be compatible for the application of work involved.**

# General Safety Instructions

## Use Of Personal Protective Equipment (PPE)

Welding arc rays from all the welding processes produce intense, visible and invisible (ultraviolet and infrared) rays that can burn eyes and skin.

- Wear an approved welding helmet fitted with an appropriate shade of filter lens to protect your face and eyes when welding or watching.
- Wear approved safety glasses with side shields under your helmet.
- Never use broken or faulty welding helmets.
- Always ensure there are adequate protective screens or barriers to protect others from flash, glare and sparks from the welding area.

- Ensure that there are adequate warnings that welding or cutting is taking place.
- Wear suitable protective flame resistant clothing, gloves and footwear.
- Check and be sure the area is safe and clear of inflammable material before carrying out any welding.

Some welding and cutting operations may produce noise. Wear safety ear protection to protect your hearing if the ambient noise level exceeds the allowable limit (e.g: 85 dB).

| Current | MMA Electrodes | MIG Light Alloys | MIG Heavy Metals | MAG | TIG On All Metals | Plasma Cutting | Plasma Welding | Gouging ARC/AIR |
|---------|----------------|------------------|------------------|-----|-------------------|----------------|----------------|-----------------|
| 10      | 8              | 10               | 10               | 10  | 9                 | 11             | 10             | 10              |
| 15      |                |                  |                  |     |                   |                |                |                 |
| 20      |                |                  |                  |     |                   |                |                |                 |
| 30      | 9              |                  |                  |     |                   |                |                |                 |
| 40      |                |                  |                  |     |                   |                |                |                 |
| 60      |                |                  |                  |     |                   |                |                |                 |
| 80      | 10             |                  |                  |     |                   |                |                |                 |
| 100     |                |                  |                  |     |                   |                |                |                 |
| 125     |                |                  |                  |     |                   |                |                |                 |
| 150     | 11             | 11               | 11               | 11  | 12                | 12             | 12             |                 |
| 175     |                |                  |                  |     |                   |                |                |                 |
| 200     |                |                  |                  |     |                   |                |                |                 |
| 225     | 12             | 12               | 12               | 13  | 13                | 13             | 13             |                 |
| 250     |                |                  |                  |     |                   |                |                |                 |
| 275     |                |                  |                  |     |                   |                |                |                 |
| 300     |                |                  |                  |     |                   |                |                |                 |
| 350     | 13             | 14               | 14               | 14  | 14                | 14             | 14             |                 |
| 400     |                |                  |                  |     |                   |                |                |                 |
| 450     |                |                  |                  |     |                   |                |                |                 |
| 500     |                |                  |                  |     |                   |                |                |                 |
| 500     | 14             | 15               | 14               | 15  | 15                | 15             | 15             |                 |

# Safety Against Fumes And Welding Gases

The HSE have identified welders as being an 'at risk' group for occupational diseases arising from exposure to dusts, gases, vapours and welding fumes. The main identified health effects are pneumonia, asthma, chronic obstructive pulmonary disease (COPD), lung and Kidney cancer, metal fume fever (MFF) and lung function changes.

During welding and hot cutting 'hot work' operations, fumes are produced which are collectively known as welding fume. Depending upon the type of welding process being performed, the resultant fume generated is a complex and highly variable mixture of gases and particulates.

Regardless of the length of welding being carried out, all welding fume, including mild steel welding requires suitable engineering controls to be in place which is usually Local Exhaust Ventilation (LEV) extraction to reduce the exposure to welding fume indoors and where LEV does not adequately control exposure it should also be enhanced by using suitable respiratory protective equipment (RPE) to assist with protecting against residual fume. When welding outdoors appropriate RPE should be used.

Prior to undertaking any welding tasks an appropriate risk assessment should be carried out to ensure expected control measures are in place.

- Locate the equipment in a well-ventilated position and keep your head out of the welding fume.
- Do not breathe the welding fume.

- Ensure the welding zone is well-ventilated and provision should be made for suitable local fume extraction system to be in place.
- If ventilation is poor, wear an approved airfed welding helmet or respirator.
- Read and understand the Material Safety Data Sheets (MSDS's) and the manufacturer's instructions for metals, consumable, coatings, cleaners and de-greasers.
- Do not weld in locations near any de-greasing, cleaning or spraying operations.
- Be aware that heat and rays of the arc can react with vapours to form highly toxic and irritating gases.

**For further information please refer to the HSE website [www.hse.gov.uk](http://www.hse.gov.uk) for related documentation.**

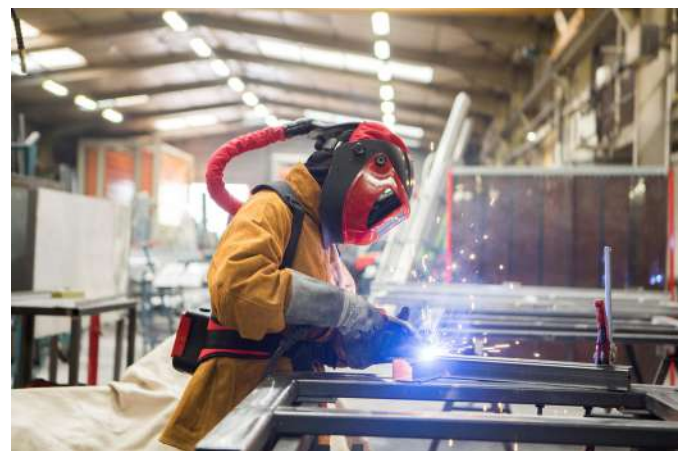

*An example of personal fume protection*

# Precautions Against Fire And Explosion

- Avoid causing fires due to sparks and hot waste or molten metal.
- Ensure that appropriate fire safety devices are available near the cutting/welding area.
- Remove all flammable and combustible materials from the cutting/welding zone and surrounding areas.
- Do not cut/weld fuel and lubricant containers, even if empty. These must be carefully cleaned before they can be cut/welded.
- Always allow the cut/welded material to cool before touching it or placing it in contact with combustible or flammable material.
- Do not work in atmospheres with high concentrations of combustible fumes, flammable gases and dust.
- Always check the work area half an hour after cutting to make sure that no fires have begun.
- Take care to avoid accidental contact of electrode to metal objects. This could cause arcs, explosion, overheating or fire.



## General Operating Safety

- Never carry the equipment or suspend it by the carrying strap or handles during welding.
- Never pull or lift the machine by the welding torch or other cables. Always use the correct lift points or handles. Always use the transport under gear as recommended by the manufacturer.
- Never lift a machine with the gas cylinder mounted on it.
- If the operating environment is classified as dangerous, only use S-marked welding equipment with a safe idle voltage level. Such environments may be for example: humid, hot or restricted accessibility spaces.

## Working Environment

- Ensure the machine is mounted in a safe and stable position allowing for cooling air circulation.
- Do not operate equipment in an environment outside the laid down operating parameters. The welding power source is not suitable for use in rain or snow.
- Always store the machine in a clean, dry space.
- Ensure the equipment is kept clean from dust build up.
- Always use the machine in an upright position.

## Protection From Moving Parts

- When the machine is in operation keep away from moving parts such as motors and fans. Moving parts, such as the fan, may cut fingers and hands and snag garments.
- Protections and coverings may be removed for maintenance and controls only by qualified personnel after first disconnecting the power supply cable.
- Replace the coverings and protections and close all doors when the intervention is finished and before starting the equipment.
- Take care to avoid getting fingers trapped when loading and feeding wire during set up and operation.
- When feeding wire be careful to avoid pointing it at other people or towards your body.
- Always ensure machine covers and protective devices are in operation.

## Handling Of Compressed Gas Cylinders and Regulators

- Always check the gas cylinder is the correct type for the welding to be carried out.
- All cylinders and pressure regulators used in welding operations should be handled with care.
- Never allow the electrode, electrode holder or any other electrically "hot" parts to touch a cylinder.
- Keep your head and face away from the cylinder valve outlet when opening the cylinder valve.
- Always secure the cylinder safely and never move with regulator and hoses connected.
- Always check for leaks.

**Never deface or alter any cylinder**

## Risks Due To Magnetic Fields

- The magnetic fields created by high currents may affect the operation of pacemakers or electronically controlled medical equipment.
- Wearers of vital electronic equipment should consult their physician before beginning any arc welding, cutting, gouging or spot welding operations.
- Do not go near welding equipment with any sensitive electronic equipment as the magnetic fields may cause damage.
- Keep the torch cable and work return cable as close to each other as possible throughout their length. This can help minimise your exposure to harmful magnetic fields.
- Do not wrap the cables around the body.

## Materials And Their Disposal

- Welding equipment is manufactured with BSI published standards meeting CE requirements materials which do not contain any toxic or poisonous materials dangerous to the operator.
- Do not dispose of the equipment with normal waste. The European Directive 2012/19/EU on Waste Electrical and Electronic Equipment states the electrical equipment that has reached its end of life must be collected separately and returned to an environmentally compatible recycling facility for disposal.

**For more detailed information please refer to the [HSE website www.hse.gov.uk](http://www.hse.gov.uk)**

**Always carry out a risk assessment before undertaking any welding or cutting activity**

# General Electrical Safety

- The equipment should be installed by a qualified person and in accordance with current standards in operation. It is the users responsibility to ensure that the equipment is connected to a suitable power supply. Consult with your utility supplier if required.
- Do not use the equipment with the covers removed.
- Do not touch live electrical parts or parts which are electrically charged.
- Turn off all equipment when not in use.
- In the case of abnormal behavior of the equipment, the equipment should be checked by a suitably qualified service engineer.
- If earth bonding of the work piece is required, bond it directly with a separate cable with a current carrying capacity capable of carrying the maximum capacity of the machine current.
- Cables (both primary supply and welding) should be regularly checked for damage and overheating. Never use worn, damaged, under sized or poorly jointed cables.
- Insulate yourself from work and earth using dry insulating mats or covers big enough to prevent any physical contact.
- Never touch the electrode if you are in contact with the work piece return.
- Do not wrap cables over your body.
- Ensure that you take additional safety precautions when you are welding in electrically hazardous conditions such as damp environments, wearing wet clothing and metal structures.
- Try to avoid welding in cramped or restricted positions.
- Ensure that the equipment is well maintained. Repair or replace damaged or defective parts immediately.
- Carry out any regular maintenance in accordance with the manufacturers instructions.
- The EMC classification of this product is class A in accordance with electromagnetic compatibility standards CISPR 11 and IEC 60974-10 and therefore the product is designed to be used in industrial environment only.

**WARNING:** This class A equipment is not intended for use in residential locations where the electrical power is provided by a public low-voltage supply system. In those locations it may be difficult to ensure the electromagnetic compatibility due to conducted and radiated disturbances.



# What Is The MIG/MAG Process?

The MIG/MAG process was developed to meet the production demands of the war and post war time economies. This process utilises an electric arc power source, continuously fed consumable wire electrode shielded by gas.

A number of terms are used for the process such as:

- MIG – Metal inert gas welding
- MAG – Metal active gas welding
- GMAW – Gas metal arc welding

## Process Description

The MIG process was first patented for the welding of aluminium in 1949 in the USA. The process uses the heat that is generated by an electric arc formed between a bare consumable wire electrode and the work piece. This arc is shielded by a gas to prevent oxidation of the weld.

In the MIG process an inert shielding gas is used to protect the electrode and weld pool from contamination and enhance the arc. Originally this gas was helium. In the early 1950's the process became popular in the UK for welding aluminium using argon as the shielding gas.

Development in the use of different gases resulted in the MAG process. This is where other gases were used, for example carbon dioxide and sometimes users refer to the process as CO2 welding. Gases such as oxygen and carbon dioxide were added and are active constituents to the inert

Selecting good welding equipment will make all the difference when it comes to welding. The wrong type or poor quality equipment can cause frustration, poor weld quality and waste a lot of time.

Whilst a wide range of welding equipment is available the development of new technologies have made equipment easier to use and set up often by automating many features allowing the welder to concentrate on welding technique.

gas to improve the welding performance. Although the MAG process is in common use today it is still referred to as MIG welding although technically this is not correct. The process began to prove itself as an alternative to stick electrode (MMA) and TIG (GTAW) offering high productivity and deposition rates. The process also helps reduce any weld defects from the increased stop/starts used in MMA. However, the welder must have a good knowledge of the system set up and maintenance to achieve satisfactory welds.

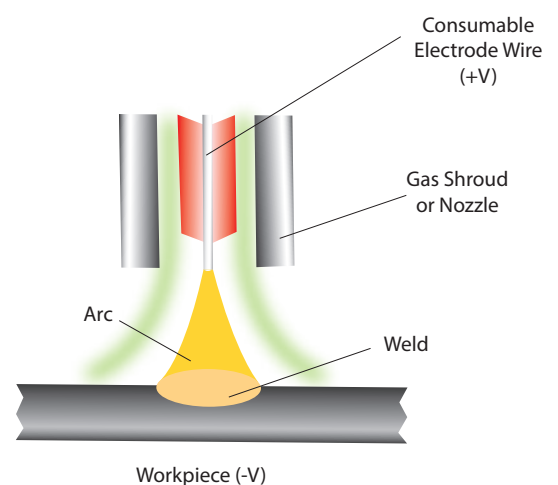

# What Makes Up The MIG Machines?

The system consists of a direct current power source, a wire feeding mechanism, shielding gas, gas regulator, welding torch and work return.

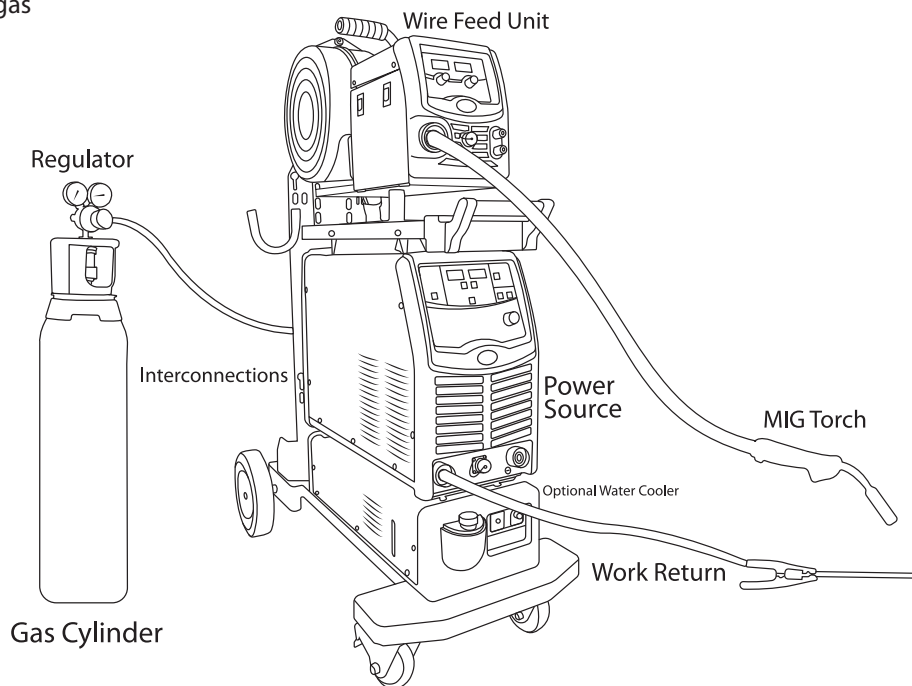

## The Power Source

The power source converts the mains supply to a usable welding supply and its output is DC. In a standard MIG power source the relationship between voltage and welding current is termed to be a flat or constant voltage characteristic.

In the MIG/MAG process, welding current is determined by wire feed speed and arc length is determined by power source voltage level (open circuit voltage). Wire burn-off rate is automatically adjusted for any slight variation in the gun to work piece distance, wire feed speed or current pick-up in the contact tip. For example, if the arc momentarily shortens, arc voltage will decrease and welding current will be momentarily increased to burn back the wire and maintain pre-set arc length.

The reverse will occur to counteract a momentary lengthening of the arc. The electrode MIG Gun is normally +VE and the work return is normally -VE. However, certain consumable wires sometimes require what is called reverse polarity i.e. Electrode -VE work +VE.



# The Wire Feeding Systems

Typical of these types of wire are cored wires used in hard facing or high deposition and gas less applications.

There are a wide range of power sources available and the mode of metal transfer can be:

- Dip
- Globular/Spray
- Pulsed

## Typical Welding Ranges:

| Wire Diameter (mm) | Dip Transfer |             | Spray Transfer |             |
|--------------------|--------------|-------------|----------------|-------------|
|                    | Current (A)  | Voltage (V) | Current (A)    | Voltage (V) |
| 0.6                | 30 - 80      | 15 - 18     |                |             |
| 0.8                | 45 - 180     | 16 - 21     | 150 - 250      | 25 - 33     |
| 1.0                | 70 - 180     | 17 - 22     | 230 - 300      | 26 - 35     |
| 1.2                | 100 - 200    | 17 - 22     | 250 - 400      | 27 - 35     |
| 1.6                | 120 - 200    | 18 - 22     | 250 - 500      | 30 - 40     |

## The Wire Feeder Mechanism

The wire feeder mechanism has a drive motor and feed roll system to feed the wire. This feed system may be built into the power source (compact) or a separate unit (SWF). Wire feed units can be either two or four roll drive.

The performance of the wire feed system can be crucial to the stability and reproducibility of MIG welding. Roll pressure must not be too high otherwise the wire will deform and this results in poor current pick up in the contact tip.

With copper coated wires, too high a roll pressure or use of knurled rolls increases the risk of flaking of the coating (resulting in copper build up in the contact tip).

**There are three types of feeding systems:**



# Feed And Pressure Pinch Rolls

The conventional wire feeding system normally has a set of rolls where one is grooved and the other has a flat surface or some drive systems may have top and bottom rolls grooved. The feed system will have a tensioner to adjust the pressure on the wire to be fed.

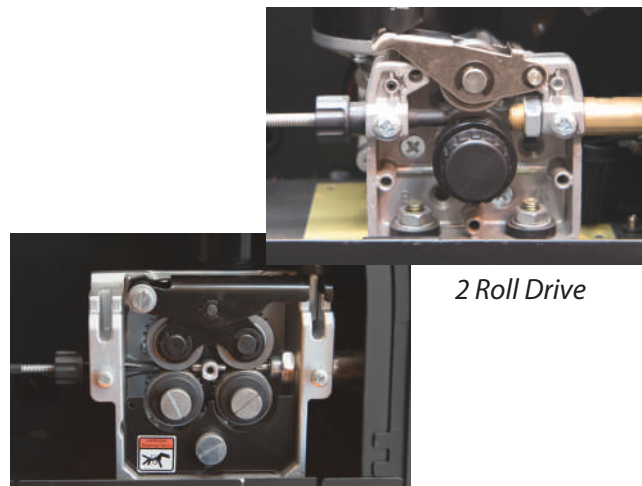

2 Roll Drive

4 Roll Drive



### V Groove Rollers:

Are used for hard wires such as steel, stainless steel where the wire shape is not deformed due to tensioner pressure.



### U Groove Rollers:

Are used for soft wires such as aluminium. This type of wire can easily deform its shape making poor current pick up at the contact tip.



### Knurled Rollers:

Are used on tubular cored wires which are easily deformed.

## Push-Pull

Small diameter aluminium wires, 1mm and smaller, are more reliably fed using a push-pull system. Here, a second set of rolls is located in the welding gun - this greatly assists in drawing the wire through the conduit. The disadvantage of this system can be the increased size of gun.



## Spool On Gun

Small wires can also be fed using a small spool mounted directly on the gun. Again, the disadvantages with this are increased size, awkwardness of the gun and higher wire cost due to small size reels. For feeding soft wires such as aluminium, dual-drive systems should be used to avoid deforming the soft wire. As the system must be capable of feeding the wire smoothly, attention should be paid to the feed rolls and liners.



## The Gas Cylinder

The gas cylinder contains gas stored under pressure usually 230 or 300 Bar and should be handled carefully. This gas shields the weld area from contaminants and enhances the welding process. In the case of carbon dioxide, the gas may be in liquid form and requires a heater to change it to vapour.

## The Regulator/Flowmeter

This regulates the cylinder pressure to a usable shielding gas pressure and controls the flow of gas. Regulators may have a built in flow control or have a separate flow meter. They come in single or multi stage configuration and normally have either single gauges or two gauges.



# The Welding Gun

The welding gun is one of the most critical parts of the system. In addition to directing the wire to the joint the welding gun fulfills two important functions. It transfers the welding current to the wire via the contact tip and the shield nozzle directs the shield gas around the arc and weld pool. There are two types of welding guns air/gas cooled and water cooled.

## Air Cooled

The air cooled guns utilise the shielding gas passing through the body to cool the nozzle and have a limited current-carrying capacity. They are suited for light duty work. Some air cooled guns are available with current ratings up to 500A but these are often heavy and not suited to extended work periods.



## Water Cooled

The water cooled guns are preferred for high current levels and especially at high duty cycles. They are much lighter in weight due to the lesser amounts of copper made possible by the cooling system.



## Contact Tips

Welding current is transferred to the wire through the contact tip whose bore is slightly greater than the wire diameter. If the bore becomes worn and enlarged it affects current pick up. Therefore, tips must be inspected regularly and changed as soon as excessive wear is noted.

Copper alloy (chromium and zirconium additions) contact tips, harder than pure copper, have a longer life especially when using spray and pulsed modes. Long tips are also preferred with the pulse welding modes.

Gas flow rate is set according to nozzle diameter and gun to work piece distance but is typically between 10 and 30 l/min. The nozzle must be cleaned regularly to prevent excessive spatter build-up which creates porosity.

Anti-spatter spray can be particularly effective in automatic and robotic welding to limit the amount of spatter adhering to the nozzle.



## The Welding Gun Liner

The liner selected must be compatible with the wire to be fed i.e. flux cored or steel would use a steel or stainless steel liner. A Teflon or carbon fibre liner would be used for aluminium. The liner must match the size of wire being used to prevent poor feeding. Be aware that one size liner may cover several wire sizes. Liner wear is often the cause of poor feeding and weld conditions.

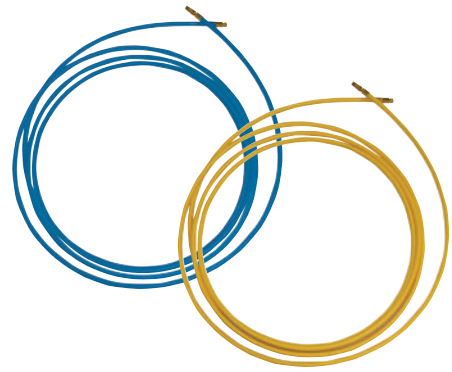

## Water Cooling

In order to provide high duty systems the units may be fitted with either an integral or separate coolant recirculation system or chiller. This can be powered from the power source or external supply and may include flow protection to stop the welding machine in the event of coolant or cooler problems.



## The Interconnections

When using a system with a separate wire drive unit this is connected to the power source by an interconnecting cable. These can be air or water cooled and various lengths. The interconnections carry welding power, shield gas and control supply for the wire feed drive. The water cooled option will also have coolant flow and return pipes.





# The Consumables

The consumables of the process are filler wires and shield gas.

## Filler Wires

Filler wires for the process come in a range of diameters e.g. 0.6mm to 2.4mm and various sizes of reel weight/diameter. The type of wire selected is chosen normally to match the material to be welded and provide the required strength.

Wires of dissimilar materials can be used for some cases which could include hard facing or brazing. Hard wires will utilise wire feed rolls with V style groove whereas soft alloy wires will require wire feed rolls with U style groove to reduce any deformation of the wire shape when pressure is applied.

Cored wires can be used for hard facing, high strength or high speed welding. These wires consist of an outer metal sheath and contain either a flux or metal powder core.

Due to the nature of the construction they often require specially designed knurled feed rolls. **For more details on individual wires please consult the material data sheets supplied by the manufacturer.**



## Gases

The shielding gas used is primarily to shield the weld zone from contamination by air. It also affects the heat of the arc, the stability of the arc and mode of transfer. The gas mixtures vary depending on the gas supplier but generally the following guidelines can be used. Gas flow rates should be around 20-30 ft<sup>3</sup>/hr.



## Steel

Carbon dioxide (CO<sub>2</sub>) can be used but generally Argon/CO<sub>2</sub> mixtures are used as they give improved transfer modes and cleaner finish to the weld.

## Stainless

Argon/Oxygen mixtures provide an economical solution but many bespoke gases containing helium and CO<sub>2</sub> can provide better transfer and weld finish.

Non Ferrous materials such as aluminium, copper nickel and alloys – argon or helium.



# Controls

The main basic controls for the MIG/MAG system are as follows. Controls can be electro mechanical or electronic but the effects will be the same.

## Wire Feed Speed

The wire speed is directly related to the current. The higher the wire speed the more wire is deposited and hence more current is required to burn off the consumable wire. Wire speed is measured in m/min (metres per min) or sometimes in ipm (inches per minute).

The diameter of the wire also forms part of the current demand e.g. a 1.0mm wire feeding at 3m per min will require less current than a 1.2mm wire feeding at the same rate.

The wire feed is set according to the material to be welded. If the wire feed rate is too high in comparison to the voltage then a “stubbing” effect happens where unmelted consumable contacts the work piece creating large amounts

of weld spatter. Too little wire feed comparison to the voltage will result in a long arc being created with poor transfer and eventual burning back of the wire onto the contact tip.



## Voltage Setting

The voltage polarity in MIG/MAG welding is in the majority of cases with the positive (+). This means that the majority of the heat is in the electrode wire. Certain special wires may require the polarity to be reversed i.e. electrode wire negative (-) polarity. Always consult the manufacturer’s data sheet for the best operating parameters.

The voltage is often referred to as the “heat setting”. This will be altered dependent on the material type, thickness, gas type, joint type and position of the weld. Combined with the wire speed it is the main control adjusted by the welder. The voltage setting varies depending on the type and size of electrode wire being used.

Most MIG/MAG welders are CV or Constant Voltage power sources which means the voltage does not vary much during welding. Modern inverter power sources also have control circuits to monitor conditions to ensure voltage remains constant.

The voltage determines height and width of the weld bead. If the operator has no reference to settings required the best method of set up is to use scrap material of the same thickness to obtain the correct setting. If there is too much voltage the arc will be long and uncontrollable and cause the wire to fuse to the contact tip. If the voltage is too low then there will not be enough heat to melt the wire and then stubbing occurs.

To obtain a satisfactory weld a balance needs to be made between voltage and wire speed. Characteristics of the voltage are that the higher voltage produces a flatter and wider weld bead but care must be taken to avoid undercut. The lower the voltage the weld bead becomes narrow and higher.

# Inductance

When MIG/MAG welding in the dip transfer mode the welding wire electrode touches the work piece/weld pool and this results in a short circuit. When this short circuit occurs the arc voltage will fall to nearly zero. This change in the arc voltage will cause a change in the welding circuit. The fall in voltage will cause a rise in the welding current. The size of the current rise is dependent upon the welding characteristic of the power source.

Should the power source respond immediately then the current in the circuit would rise to a very high value. The rapid increase in current would cause the short circuited welding wire to melt similar to an explosion creating a large amount of molten weld spatter.

By adding inductance to the weld circuit this will slow down the rate of current rise. It works by creating a magnetic

field which opposes the welding current in the short circuit thereby slowing the rate of rise. If the inductance is increased it will cause an increase in arc time and reduction in the dip frequency, this will help reduce spatter.

Depending on the welding parameters there will be an optimum inductance setting for the best welding conditions. If the inductance is too low then there will be excessive spatter. If the inductance is too high the current will not rise high enough and the wire will stab the weld pool with insufficient heat. The modern technology welding power sources often have the ability to provide the correct inductance to provide excellent weld characteristics. Many have a variable inductance control to give precise control.



Inductance

# Burn Back

In the event that the welder was to stop welding and all functions of the machine stopped simultaneously then the consumable filler wire would in all likelihood freeze in the weld pool. In order to avoid this happening the burn back feature is present on most machines.

This facility may be built in or an adjustable control. It will allow the power and gas shield to be maintained on the consumable filler wire when it has stopped feeding thereby burning clear of the weld. In some equipment the burn back is preset within the control circuits others offer an external variable control feature to adjust the time of delay.

# Other Controls

Other common control features are latching or 2T/4T where the welding can either in 2T mode press the torch trigger to weld and release to stop or in 4T press and release the torch trigger to start, weld without holding the trigger on and stop by pressing and releasing the trigger again. This is particularly useful when welding long weld runs.

Crater fill controls are available on many machines. This allows the crater at the end to be filled helping eliminate welding defects.

A spot welding timer will allow the time of the weld to be set and after the time has expired the operator will have to release the torch switch to restart the weld.

In smaller auto body type machines there are sometimes switch welding timers. These timers set an on and off time which allows the welder to operate the torch switch and weld for the preset time then pause for a preset time without releasing the torch switch. This process will continue until the switch is released.

In many of the new technology machines there are numerous other control features made possible by the use of electronics and micro computers such as synergic control, pulse and double pulse etc.

These can greatly improve both machine and welder performance and the operator should always read the manufacturer's instructions to gain a full knowledge of all these additional features.

# Modes Of Transfer

## Dip Or Short Circuit Mode

In the dip or short circuit, the wire (electrode) touches the work piece and a short circuit is created. The wire will short circuit the base metal between 90 and 200 times per second. This method has the benefit of creating a small, quickly solidifying weld puddle. The deposition rates, wire speed and voltages are usually lower than other modes of transfer and the low heat input makes it a flexible mode for both thick and thin metals in all positions.

- A.** Consumable wire feed to work piece and short circuit is created
- B.** Wire starts to melt due to short circuit current
- C.** Wire pinches off
- D.** Arc length opens due to burn off
- E.** Wire advances towards the work piece
- F.** Wire short circuits and the process cycles again

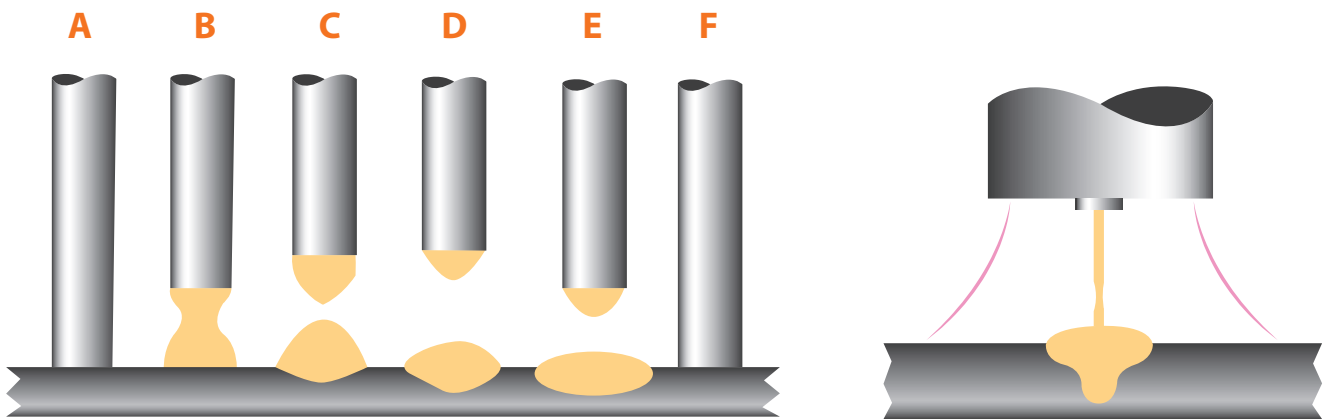

Some of the disadvantages of this method are limited wire feed speed and hence weld deposition rates. On the thicker materials there can also be a danger of “cold lapping” occurring. This occurs when there is not enough energy in the weld puddle to fuse properly. Another disadvantage is that this mode produces an increased amount of spatter

due to the short circuits especially compared to the other transfer methods. An inductance is used to control the surge in current when the wire dips into the weld pool. Modern electronic power sources can automatically set the inductance to give a smooth arc and metal transfer.

## Globular Transfer Mode

The globular transfer method is in effect an uncontrolled short circuit which occurs when the voltage and wire are above the dip range but too low for spray. Large irregular globules of metal are transferred between the torch and work piece under the force of gravity. The disadvantages of this method of transfer are that it produces a large amount of spatter as well as high heat input. In addition, globular transfer is limited to flat and horizontal fillet welds above 3mm. Lack of fusion is often common because the spatter disrupts the weld puddle. Also, because globular transfer uses more wire it is generally considered less efficient. The advantages of globular transfer are that it runs at high wire feed speeds and amperages for good penetration on thick metals. Also, when weld appearance is not critical it can be used with inexpensive, CO<sub>2</sub> shielding gas.

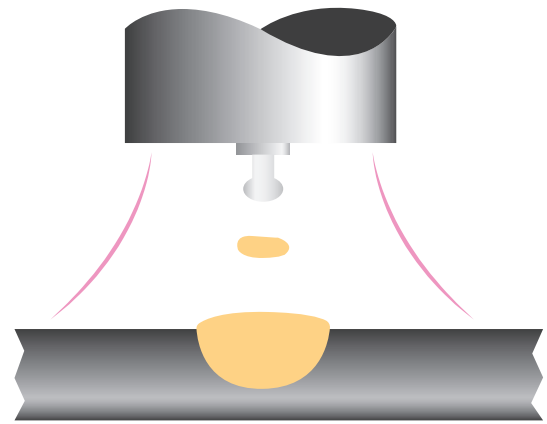

## Spray Arc Mode

The Spray arc mode is used with high voltage and current. Metal is projected in the form of a fine spray of molten droplets of the electrode, propelled across the arc to the work piece by an electromagnetic force without the wire touching the weld pool.

Its advantages include high deposition rates, good penetration, strong fusion, excellent weld appearance with little spatter as no short circuits are occurring. The disadvantages of the spray arc mode are mainly due to the high heat input which can cause problems on thinner material and the limited range of welding positions where the mode can be used. Generally, the minimum thickness to be welded will be around 6mm.

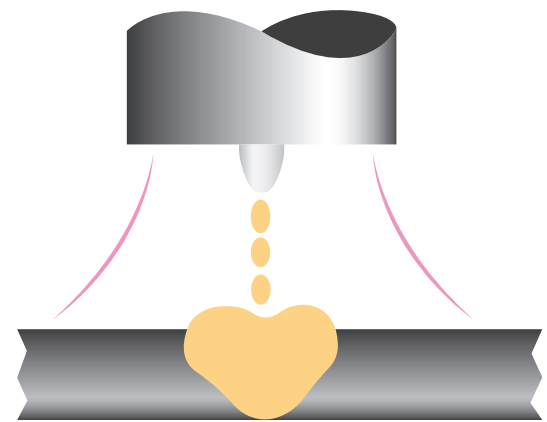

# Pulsed Arc Mode

Pulsed MIG is an advanced form of welding that takes the best of all the other forms of transfer while minimizing or eliminating their disadvantages. Unlike short circuit, pulsed MIG does not create spatter or run the risk of cold lapping. The welding positions in pulsed MIG are not limited as they are with globular or spray and its wire use is definitely more efficient. By cooling off the spray arc process, pulsed MIG is able to expand its welding range and its lower heat input does not encounter the problems on thinner materials. In basic terms, pulsed MIG is a transfer method where material is transferred between the electrode and the weld puddle in controlled droplet form. This is achieved by controlling the electrical output of the welding machine using the latest control technologies. The pulsed MIG process works by forming one droplet of molten metal at the end of the wire electrode per pulse. When ready the pulse of current is used to propel that one droplet across the arc and into the puddle.

Pulsed MIG welding has had quite an evolution since it was first introduced to the marketplace. In the 1980's, the process was highly complex and was in general performed by the most skilled welders. The process was highly dependent on the operator skill and knowledge to know exactly how to set the machine parameters.

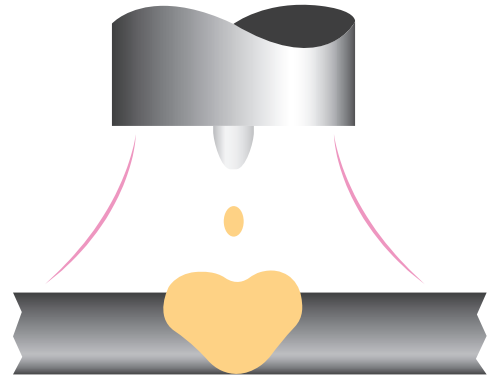

Today, the development of equipment utilising the latest technologies and programming removes many of the complexities. The machines often have pulse, double pulse modes, contain a large library of welding programs, automated setups and programming features. As a result, the operator can set just a very few relevant parameters and the control will automatically adjust all the other parameters. This is often referred to as "synergic" control. The synergic operation of the machine makes it easy to use even for relatively new and inexperienced welders. Its sophisticated control and monitoring electronics are "adaptive" to adjust for variations in conditions such as arc length, material gap etc. Many of these state of the art power sources on the market today are those that provide pulsing capabilities. They are often presented to make welding easier for the operator and produce a high quality welding result with an excellent "cosmetic" finish.



What is often not understood is that these machines can also result in cost savings. Initial capital investment on the machine may be higher than conventional power sources but the advantages they present will often reduce the overall welding costs and provide a higher return on your investment in the long run.

# Key Advantages To MIG

- **Improved Productivity**

Pulsed MIG offers high deposition rates. In addition, since the new machines are simpler and adaptive, it is easier to weld with pulsed MIG than other transfer methods, this results in less time spent training.

- **Consumable Savings**

The Pulsed MIG machines due to their control offer a wider operating range as they extend the low and high range of each wire diameter. Therefore, instead of using and stocking several different wire diameters to cover different applications for example 0.8, 1.0, 1.2mm one wire size 1.2mm can be used. This in turn results in better pricing for more volume purchases of the one size wire, one size consumables (Mig torch, tips, liners, etc.) and reduced changeover labour costs as there is no need to keep changing feed rolls and other consumables.

- **Improved Weld Quality**

All the advantages of Pulsed MIG process result in overall better quality of the finished weld. The more stable arc and spatter free welding, results in labour savings in weld finishing and additional clean up and grinding. The technology of these power sources also provide these high quality welds to be made by welders with relatively less training.

- **Spatter and Fume Reduction**

Compared to conventional MIG/MAG, Pulsing offers reduced spatter and fume. A reduction in weld spatter results in cost savings because more of the melted electrode wire is transferred to the weld joint and not as waste surface spatter on the product and surrounding work area. A reduction in the welding fumes creates a safer and healthier environment for the work area and workshop in general.

- **Heat Reduction**

Pulsing offers controlled heat input leading to less distortion and improved overall quality and appearance which means fewer production problems. This is especially important with stainless, nickel and other alloys that are sensitive to heat input.

- **Energy Saving**

The new technology inverter power source is very energy efficient and many have hibernating functions which provide energy on demand and can often cost less than a 60w light bulb to run in standby mode.

## MIG Brazing

Brazing was often looked upon as a poor alternative to welding. However the introduction of new material types particularly in the auto body construction area which cannot be welded using conventional processes because of the resultant metallurgical changes that weaken the parent metal has led to the increase of MIG brazing as a solution for automotive repairs and other applications.

The brazing process was a popular process in the past but as new joining methods such as new modern adhesives

and better welding techniques were introduced it became less widely used. The brazing process offered the welder the features of aesthetics, strength and durability and the advantage of the fact that the process takes place at temperatures much lower than those required for normal welding. This means that problems such as distortion and embrittlement in the heat-affected zone are greatly reduced.

One of the advantages of brazing is that the braze material forms a strong metallurgical bond with the parent metals but there is no requirement for the materials being joined to be the same grade or even the same material.

With the introduction of the latest generation of steels for automotive body construction there has been renewed interest in brazing as a high-strength joining technique. The new materials have been introduced in order to save weight and achieve better protection for vehicle occupants.

The automotive manufacturers have started to use higher-strength steels and materials. Various advanced high-strength steel (AHSS) and ultra-high-strength steel (UHSS) grades are now used in different areas of the body structure. Dual-phase (DP) steels are advantageous for energy-absorption structures, while TRIP (transformation induced plasticity) steel is used for energy-absorption elements and sections such as front floor panels.

Where there is also a requirement for high formability, HSLA (high-strength, low-alloy) steel offers a combination of high strength and good weldability, complex-phase steels can be used for floor members and other areas where reinforcement is required and martensitic steels have extremely high strength and are used for reinforcement of areas such as the B-pillar and tunnel. Other terms encountered in this field are boron steel and manganese-boron steel.

The excellent physical material characteristics of these latest-generation steels are derived from heat treatment processes. It therefore follows that these steels are more easily affected by heat. Therefore, they cannot be readily MIG welded though spot welding is still possible. Also, the modern

automotive steels tend to be zinc-coated meaning that the higher temperatures encountered with welding burn off the zinc coating and adversely affect both the joint strength and the subsequent corrosion resistance of the steel.

It is for these reasons there is an increase in the interest in brazing. When welding, the temperature needs to be raised to the melting point of the parent metal, brazing however takes place at lower temperatures which minimises damage to the zinc coating and does not change the metallurgy of high-strength and ultra-high-strength steels.

MIG brazing is a popular way to apply the braze. In many cases a standard MIG/MAG machine can be used but there are also machines designed specifically for the process. Manual MIG brazing is used widely in automotive body repair shops where it is important to avoid using traditional repair techniques on high-strength and ultra-high-strength steels.

Typically, the brazing wire will be a copper-silicon alloy and the MIG process has the added advantage of not needing a flux. Pure argon is often used as the shielding gas to maintain a stable arc. The best results tend to be achieved with a synergic welding machine with a facility for pulsed MIG brazing, giving a combination of good speed, high strength and a finish that requires little or no dressing. Unlike with welding, it is necessary to have a small gap between the components being joined so that the molten braze can penetrate by means of a capillary action.

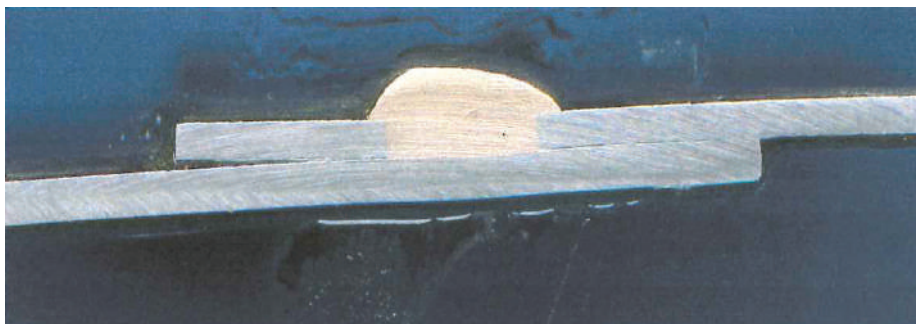

# Future Vehicle Steels

Aluminium and composite materials may appear to be the obvious choice for lightweight vehicles but the world's steel producers are arguing that steel offers a good combination of strength, stiffness, weight and cost as well as being easy to

recycle. Given the extensive use of high-strength and ultra-high-strength steels, it seems likely that MIG brazing would be needed to carry out repairs to vehicles using these materials.

# MIG/MAG Process Applications

The process is suited to use on a wide range of metals and applications.

## Dip Or Short Circuit Mode

The dip or short circuit mode of the process is used predominantly in two areas. The low controlled heat input operation can be used on thin materials from 0.5mm to 5mm thick. Above 5mm the mode can be used in positional welding i.e. vertical, overhead etc

Typical applications of both processes are:

### Low currents welding up to 5mm

- Auto body repair
- HV ductwork
- Sheet metal shops
- Tube furniture
- Storage tanks
- Exhaust manufacture
- DIY

### Typical positional applications over 5mm

- Shipbuilding
- Structural steelwork
- Fabrication

## Spray Arc Mode

The high heat input of this process makes it well suited to the high speed welding of thicker section materials. This mode of transfer is normally used in either the down hand mode or horizontal vertical mode.

Typical applications would be:

### Low currents welding up to 5mm

- Pre-fabricated structural steel
- Heavy duty equipment such as earth movers and cranes
- Deposition of wear or hard facing materials for digger teeth etc.

## Using Aluminium

- Military vehicles such as tanks and personnel carriers
- Heavy duty tanks such as liquid gas storage

## Globular Transfer Mode

Due to its mode of transfer this process can only be used in the down hand mode. Usually it would be limited to thick section steel work in conjunction with CO<sup>2</sup> gas.

**It can also be utilised with cored wires in applications such as:**

- High deposition
- Hard facing/surfacing
- Heavy equipment fabrication

## Pulsed Arc Mode

This mode utilises the best features of all the other modes and in conjunction with modern power sources and controls can be used in a wide range of materials, thicknesses and positions. It can be used where heat input needs to be controlled, positional welding and for spatter free welding with high quality finish.

**Some applications include:**

- Aluminium fabrications such as shipbuilding
- Stainless fabrications
- Special alloys which require low heat input

# MIG/MAG Process Features And Benefits

The MIG/MAG process has a number of features and benefits over other modes especially if the correct method is used.

- It can weld most commercial metals and alloys including steel, aluminium and stainless steel.
- The simple techniques are easy to learn as the constant feeding of the consumable wire allows the operator to concentrate on the arc control.
- It can be easily mechanised for repetitive welding.
- The process allows for greater speed and efficiency compared to the MMA and TIG process resulting in faster welding with reduced labour costs.
- It can be used in almost all positions.
- A wide range of current can be used for a single wire diameter allowing a variety of joints to be made without changing consumable or equipment.
- Continuously fed consumable wire reduces down time due to changeover.
- The process is a “low hydrogen” process with reduced danger of hydrogen pick up. Alloy steels are weldable with less risk of cold cracking and no special treatment of the consumables is required such as drying ovens.
- Less weld defects caused by stop starts in the weld time.
- Approximately 98% of the consumable wire is converted to weld material compared to 65% with MMA welding.
- Produces little or no slag (weld shield formation) helping reduce weld defects such as slag inclusion.
- The arc pool is clearly visible during welding.
- There is low wastage with the MIG/MAG process compared to MMA and minimal post weld clean up required saving time and reducing labour cost.

## MIG/MAG Welding Tips And Guides

Whatever your choice of power source, always read your owner’s manual. This contains important information about the correct operation and safety guidelines which should be observed.

### Some quick reference handy tips for the MIG/MAG welding process are:

- When welding, try to use an electrode stick out (the distance between the weld and the contact tip) of around 6-8mm.
- When welding thin materials try and use smaller wire diameters and for thicker materials use thicker wires.
- Make sure you select the correct wire type for the material to be welded.
- Ensure the welding gun has the correct size and type of liner.
- Always ensure you have the correct size drive rolls and torch liner for the wire size selected.
- Select the correct gas to achieve the correct weld characteristics and finish.
- For optimum control of the weld keep the wire at the leading edge of the weld pool.
- Before commencing welding, ensure a comfortable and stable position.
- Try to keep the welding torch as straight as possible when welding to ensure the best feed.
- Carry out daily housekeeping on the condition of the welding torch and drive rolls.
- Keep any consumables clean and dry to avoid contamination such as oxidation and damp.

## Welding Carbon Steels

### In order to weld these materials you must:

- Use the correct welding gas, usually ARGON + CO<sub>2</sub> with percentages of argon ranging from 75% upward.
- Using pure CO<sub>2</sub> as a protection gas will produce narrow beads with greater penetration but a considerable increase in spatter.
- Use a welding wire of the same quality as the steel to be welded. It is best to always use good quality wires and avoid welding with rusted wires that could cause welding defects.
- Avoid welding rusted material or that with oil or grease contamination.

## Welding Stainless

- Ensure the correct gas mix for stainless steels is used. Usually a protection gas with a high argon content containing a small percentage of O<sub>2</sub> or carbon dioxide CO<sub>2</sub> (approximately 2%) to stabilize the arc.
- It is important to keep the welding area clean at all times to avoid contaminating the joint to be welded.

# Welding Aluminium

In order to weld aluminium you must use:

- Pure argon or argon helium mix as the protection gas.
- A welding wire with a composition suitable for the base material to be welded.
- NOTE: If only a torch prepared for steel wires is available, it must be altered as follows:
- Make sure that the cable is as short as practicable, if possible no more than 3 metres long.
- Remove the brass liner nut, gas nozzle, contact tip and then take out the steel liner.
- Insert a Teflon or carbon fibre liner making sure that it protrudes from both ends.
- Screw the contact tip back on so that the liner butts up to it.
- At the free end of the liner insert the liner nipple and O-ring and fasten with the nut without over-tighten.
- Use wire feeder rollers suitable for aluminium wire.
- Adjust the pressure exerted by the arm of the wire feeder group on the roller to the lowest possible setting.
- Consider the use of a push-pull or spool on gun type welding gun to aid wire feed consistency.
- Ensure that the contact tips are suitable for use with aluminium.
- Make sure the material to be welded is clean.
- Remember to fill the crater at the end of the weld to reduce weld defects.

## Maintaining The System

### Shielding Gas Nozzle

This nozzle must be periodically cleaned to remove weld spatter. Replace if distorted or squashed.

### Contact Tip

Only a good contact between this contact tip and the wire can ensure a stable arc and optimum current output; you must therefore observe the following precautions:

- The contact tip hole must be kept free of grime and oxidation (rust).
- Weld spatter sticks more easily after long welding sessions, blocking the wire flow, the tip must therefore be cleaned often and replaced if necessary.
- The contact tip must always be firmly screwed onto the torch body. The thermal cycles to which the torch is subjected can cause it to loosen, thus heating the torch body and tip and causing the wire to advance unevenly.

## Wire Liner

This is an important part that must be checked often because the wire may deposit copper dust or tiny shavings. Clean it periodically along with the gas lines using dry compressed air. The liners are subjected to constant wear and tear and therefore must be replaced after a certain amount of time.

## Wire Drive Group

Periodically clean the set of feeder rollers to remove any rust or metal residue left by the coils. You must periodically check the entire wire feeder group: feed arms, wire guide rollers, liner and contact tip.

# MIG Welding Problems

| Defect                                         | Possible Cause                                                                                     | Action                                                                                                                        |
|------------------------------------------------|----------------------------------------------------------------------------------------------------|-------------------------------------------------------------------------------------------------------------------------------|
| Porosity<br>(within or outside the bead)       | Poor material                                                                                      | Check the material is clean                                                                                                   |
|                                                | Insufficient shield gas flow                                                                       | Check for blockages<br>Air draft at welding zone                                                                              |
|                                                | Gas flow too low/high                                                                              | Check the regulator setting or that it is not frozen due to a high flow                                                       |
|                                                | Leaking Hoses                                                                                      | Check all hoses for leaks                                                                                                     |
|                                                | Faulty gas valve                                                                                   | Call a service engineer                                                                                                       |
| Poor wire feed                                 | Incorrect pressure on wire drive causing burn back to contact tip or bird nesting at the feed roll | Reset the feed pressure<br>Increase the pressure to eliminate burn back to tip<br>Decrease pressure to eliminate bird nesting |
|                                                | Damage to torch liner                                                                              | Replace torch liner                                                                                                           |
|                                                | Welding wire contaminated or rusty                                                                 | Replace wire                                                                                                                  |
| No operation when the torch switch is operated | Torch switch faulty                                                                                | Check the torch switch continuity and replace if faulty                                                                       |
|                                                | Mains fuse blown                                                                                   | Check fuses and replace if necessary                                                                                          |
|                                                | Fault inside the equipment                                                                         | Call a service engineer                                                                                                       |
| Low output current                             | Loose or defective work clamp                                                                      | Tighten / replace clamp                                                                                                       |
|                                                | Loose cable plug                                                                                   | Re-fix plug                                                                                                                   |
|                                                | Power source faulty                                                                                | Call a service engineer                                                                                                       |
| No Operation                                   | No operation and mains lamp not lit                                                                | Check mains fuse and replace if required                                                                                      |
|                                                | Faulty power source                                                                                | Call a service engineer                                                                                                       |
| Excessive spatter                              | Wire speed feed too high or welding voltage too low                                                | Reset the parameters according to the weld be made                                                                            |

# Duty Cycle Explained

One of the most often misquoted and misunderstood terms in the welding industry is the term “duty cycle”. Hopefully we can clarify this term below. Industrial welding power sources are rated on a duty cycle or duty factor basis. There may be some “hobby type MMA units” which are sometimes quoted in electrodes per period.

The duty cycle or duty factor is the ratio for a given time interval of the on load duration to the total time.

**(The European norm EN 60974-1 states that the time period for one complete cycle is 10 minutes).**

So in the case of a Jasic JM-352 which has a duty cycle of 350 amps at 40% this would mean the output of 350 amps could be maintained for 4 minutes after which a rest period of 6 minutes should be observed. This would represent a complete cycle. It should however be noted that using the machine for say four periods of 1 minute at 350 amps in the 10 minute period also represents the same 60% duty cycle. Manufacturers that manufacture to the European norm EN 60974-1 often quote a number of duty cycle ratings on the rating plate.

**For example, the JM-500P is quoted at:**

| Duty cycle % | Output Current |
|--------------|----------------|
| 100          | 370A           |
| 60           | 500A           |

A 100% rating is the continuous rating for the machine and it can be seen that as the duty cycle % increases the current decreases.

## Important points to consider when selecting a machine with a suitable duty cycle are:

- The European norm EN 60974-1 states that welding power sources should be capable of delivering their rated output when the ambient air temperature is within the range of -10°C to +40°C. Consider that the normal temperatures in the UK fall into this band with good margins.
- The thermal trip will not operate in accordance with duty cycle ratings.
- When a machine is put into use it will be at ambient air temperature and may take several hours to bring it to “working temperature” before encountering thermal trip problems. It is during this period that the duty cycle is often ignored and heat builds up within the machine.
- The duty cycles achieved by most manual welding processes are often quite low, for example, MMA 10-20% MIG 30-40% TIG 20-25%. These figures should be considered when selecting equipment.
- Often a machine is selected which requires operating parameters that are within the range of the machine. But care should be taken to also ensure the machine construction is of suitable design i.e. mechanical components, switching requirements etc.

# Estimating Duty Cycles

To make a quick estimation of the duty cycle of a machine other than the stated rated outputs, the following formula can be used:

$$D_n = (I/I_n)^2 \times D$$

Where:

$D_n$  = Required Duty Cycle [%]

$I$  = Rated Current at the required Duty Cycle [A]

$I_n$  = Maximum Current at the required Duty Cycle [A]

$D$  = Rated Duty Cycle [%]

## Example:

Using Power Source rated at 200A at 60% Duty Cycle. The power source is operating at 250A what will be the duty cycle % ?

$$D_n = (200/250)^2 \times 60$$

$$D_n = (0.8)^2 \times 60$$

$$D_n = 38.4\%$$

To make a quick estimation of the current of a machine at a specific duty cycle other than the rated one the following formula can be used:

$$I_m = I \times \sqrt{(D/D_n)}$$

$I_m$  = Maximum Current at the required Duty Cycle [A]

$I$  = Rated Current at the required Duty Cycle [A]

$D$  = Rated Duty Cycle [%]

$D_n$  = Required Duty Cycle [%]

## Example:

The maximum output current at a duty cycle of 100% will be calculated by:

$$I_m = 200 \times \sqrt{(60/100)}$$

$$I_m = 200 \times 0.775$$

$$I_m = 155A$$

**Please note: The resultant figure is approximate but will give a good guide. If the formula is used with inverter unit this formula may not provide accurate results due to the machine designs and constraints.**





A series of horizontal lines for writing, with a dark grey curved shape at the top right corner.



**WILKINSON  
STAR**

Exclusive UK Importer & Master Distributor  
of JASIC Industrial Welding Equipment

Supported by a 5 Year Warranty



**wilkinsonstar247.com**

Wilkinson Star Limited, Shield Drive, Wardley Industrial Estate, Worsley,  
Manchester M28 2WD • +44 (0)161 793 8127



@wilkinsonstaruk



/wilkinsonstaruk